

airmaster



100L BELT DRIVEN AIR COMPRESSOR MODEL NO: AIRMASTER 14/100P

PART NO: 2245307

OPERATION & MAINTENANCE INSTRUCTIONS



ORIGINAL INSTRUCTIONS

GC1122 Rev1

INTRODUCTION

Thank you for purchasing this CLARKE Air Compressor.

Before attempting to operate the machine, it is essential that you read this manual thoroughly and follow all instructions given. This will ensure the safety of yourself and others and you can look forward to the product giving you long and satisfactory service.

GUARANTEE

This CLARKE product is guaranteed against faulty manufacture for a period of 12 months from the date of purchase. Please keep your receipt as proof of purchase.

This guarantee is invalid if the product is found to have been abused or tampered with in any way, or not used for the purpose for which it was intended.

Faulty goods should be returned to their place of purchase, no product can be returned to us without prior permission. This guarantee does not effect your statutory rights.

ENVIRONMENTAL RECYCLING POLICY



By purchasing this product, the customer is taking on the obligation to deal with its safe disposal in accordance with the Waste Electrical and Electronic Equipment (WEEE) regulations. In effect, this means that this product must not be disposed of with general household waste but according to the laws governing Waste Electrical and Electronic Equipment (WEEE) at a recognised disposal facility.







If disposing of this product or any damaged components, do not dispose of with general waste. This product contains valuable raw materials. Metal products should be taken to your local civic amenity site for recycling of metal products.

SAFETY PRECAUTIONS

Before using your compressor it is in your own interest to read and pay attention to the following safety rules.

1. Compressed air is dangerous. **DO NOT** point a jet of air at persons or animals, and do not discharge compressed air against the skin.
2. **DO NOT** operate your compressor with the guard removed.
3. Repairs must only be carried out by a qualified engineer. If problems occur, contact your CLARKE dealer.
4. Before carrying out any maintenance make sure that the pressure is released from the air reservoir and that the compressor is disconnected from the electrical supply.
5. **DO NOT** leave pressure in the receiver overnight or when transporting.
6. **DO NOT** adjust or tamper with the safety valves. The maximum pressure is factory set, and clearly marked on the compressor.
7. **DO NOT** operate in wet or damp conditions. Keep the compressor dry at all times. Similarly, clean air will allow the compressor to work efficiently. **DO NOT** use in dusty or otherwise dirty locations.
8. Some of the metal parts can become quite hot during operation. **DO NOT** touch/ remove these until the compressor has cooled down.
9. **ALWAYS** set the pressure regulator to the recommended setting for the tool.
10. When spraying flammable materials e.g. cellulose paint, ensure that there is sufficient airflow and keep clear of any source of ignition.
11. Before spraying any material always consult paint manufacturers instructions for safety and usage.
12. Protect yourself. Goggles will protect your eyes from flying particles. Face masks will protect you against paint spray and fumes.
13. **DO NOT** apply strain to electrical cables and make sure that air hoses are not kinked or wrapped around the compressor.
14. When disconnecting air hoses or other equipment from your compressor, make sure that the air supply is turned off at the outlet and vent all pressurised air from within the reservoir and other equipment attached to it.
15. Make sure that children and animals are kept well away from the compressor and any equipment attached to it.
16. Make sure that all individuals using the compressor have had any necessary training and have read and fully understand these operating instructions.
17. Make sure that any equipment or tool used in conjunction with your compressor, has a safe working pressure exceeding that of the compressor.
18. Be careful when transporting the compressor to prevent tipping over.
19. Permanently installed systems must be installed by a competent engineer.
20. These compressors produce noise levels in excess of 70dB(A). Persons working near the compressor must be supplied with ear protection.

SAFETY SYMBOLS

	Read this instruction booklet carefully before positioning, operating or adjusting the compressor.
	Risk of electric shock. The compressor must be disconnected from the mains supply before removing any covers. DO NOT use in a damp environment.
	Risk of accidental start-up. The compressor could start automatically in the event of a power cut and subsequent reset. DO NOT move the compressor while it is connected to the power source, or when the tank is filled with compressed air.
	This compressor contains surfaces which may reach a high temperature during operation. NEVER operate with the motor housing removed.
	Wear safety goggles when using this compressor
	Wear ear protectors when using this compressor
 LWA 97 dB	This compressor produces a high sound level during operation.

ELECTRICAL CONNECTIONS



WARNING: READ THESE ELECTRICAL SAFETY INSTRUCTIONS THOROUGHLY BEFORE CONNECTING THE PRODUCT TO THE MAINS SUPPLY.

Connect the mains lead to a standard, 230 Volt (50Hz) electrical supply through an approved 13 amp BS 1363 plug, or a suitably fused isolator switch. If the plug has to be changed because it is not suitable for your socket, or because of damage, it must be removed and a replacement fitted, following the wiring instructions shown below. The old plug must be discarded safely, as insertion into a power socket could cause an electrical hazard.



**WARNING: THE WIRES IN THE POWER CABLE OF THIS PRODUCT ARE COLOURED IN ACCORDANCE WITH THE FOLLOWING CODE:
BLUE = NEUTRAL BROWN = LIVE YELLOW AND GREEN = EARTH**

- The BLUE wire must be connected to the terminal which is marked N or coloured black.
- The BROWN wire must be connected to the terminal which is marked L or coloured red.
- The YELLOW AND GREEN wire must be connected to the terminal which is marked E or  or coloured green.

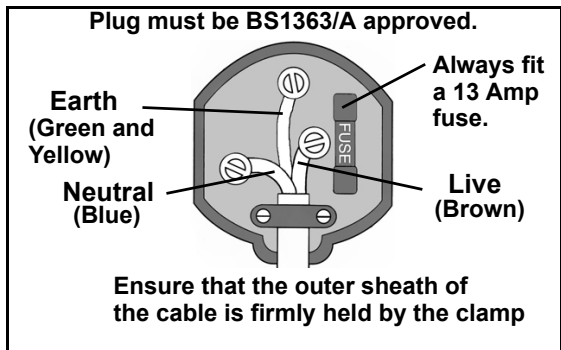

We strongly recommend that this machine is connected to the mains supply through a Residual Current Device (RCD).

If you are not sure, consult a qualified electrician. DO NOT try to do any repairs.

ASSEMBLY



CAUTION: TO PREVENT INJURY, GET ASSISTANCE WHEN LIFTING THIS COMPRESSOR.

ATTACH THE WHEELS

1. Slide the axle through the wheel and hole in the wheel frame.
 - Use the same hole on each side and make sure that the machine is horizontal to the floor.
2. Lock the wheel in place using the washer and nut provided.
3. Fit the cap into the position shown.

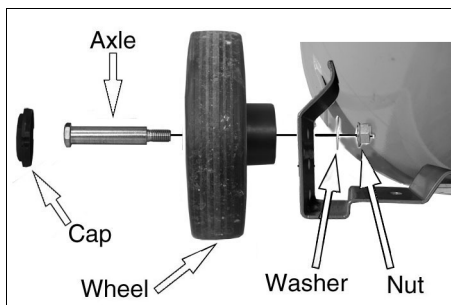

ATTACH THE SUPPORT FEET

Insert the support feet into the position shown.



BEFORE USE



CAUTION: TO PREVENT INJURY, GET ASSISTANCE WHEN LIFTING OR MOVING THIS COMPRESSOR.

Before connecting your compressor to the power supply, check the following:-

- Push down the OFF button.

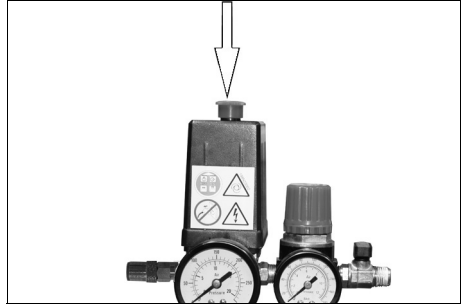

- Remove the protective plastic moulding from the top of the cylinder head.
- Make sure that the compressor is on level ground.
- Make sure that the supply voltage matches the voltage shown on the data label.

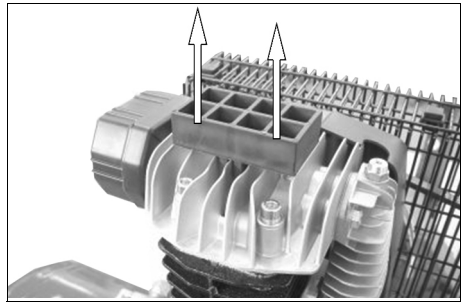

CHECK THE OIL LEVEL

1. Ensure the oil level is between the min and max marks on the sightglass.
 - Only use CLARKE -ISO100 (SAE30) compressor oil, available from your CLARKE dealer Part No. 3050796.
 - Take care not to overfill.

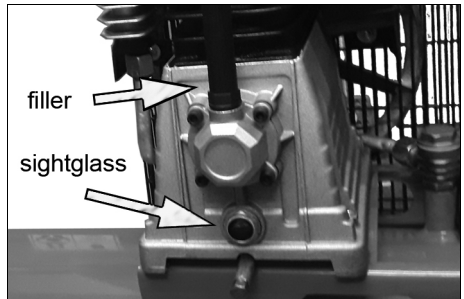

OPERATION

If the compressor has not been used for more than 24 hours, open the drain valve (on the bottom of the reservoir) and drain any condensate which has collected. See page 11.

MOVING THE AIR COMPRESSOR

- Stop the compressor and disconnect it from the power supply before you move it.
- Always use the handle.
- Do not lift by (or put strain on) valves or hoses.

ATTACHING AIR TOOLS



WARNING: BEFORE CONNECTING AIR TOOLS, MAKE SURE THAT YOU READ THE INSTRUCTIONS SUPPLIED WITH THE TOOL, ALSO ENSURE THAT THE TOOL IS SUITABLE FOR USE WITH THE COMPRESSOR AND HOSE SPECIFICATIONS.

1. Attach the air hose to the outlet valve.
2. Attach the air tool to the other end of the air hose.

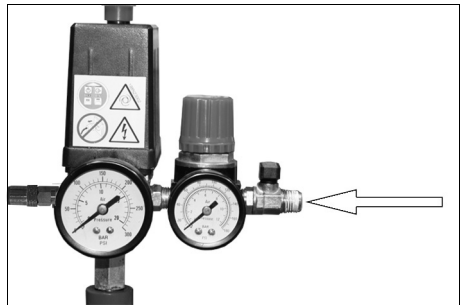

3. Turn the outlet valve handle to the on position.

NOTE: The outlet valve is shown without the air hose fitted for clarity.

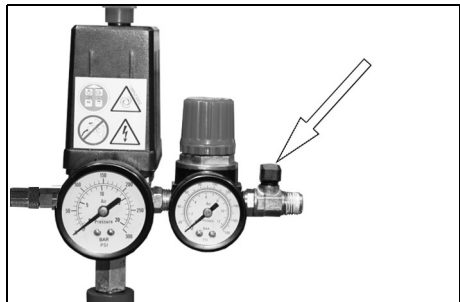

TURNING THE COMPRESSOR ON

1. Plug the compressor into the power supply.
2. Lift the On/Off button.
 - The compressor will operate until the reservoir is fully pressurised. It will then shut down.
 - The compressor will start up again when the pressure in the reservoir decreases.

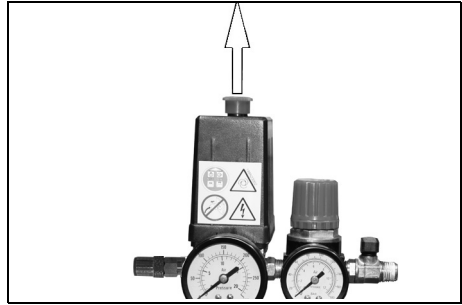

CHECKING THE SAFETY VALVE

To make sure that the safety valve works correctly.

1. Unscrew and pull the knurled part of the safety valve.
 - Air will be released when you pull hard on the valve end and stop when released.
2. If the valve does not operate in this way, do not use the compressor. The compressor must be repaired by a qualified service agent.
3. Once tested screw the knurled part back in.

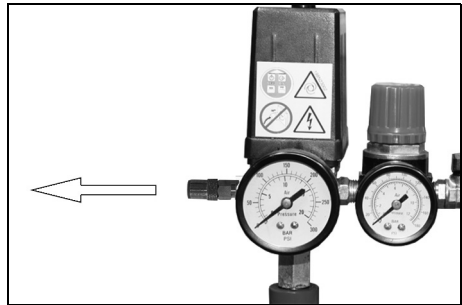

WARNING: DO NOT REMOVE OR TRY TO ADJUST THE SAFETY VALVE.



SETTING THE OUTLET PRESSURE

1. Use the pressure regulator to set the outlet pressure.
 - Turn clockwise to increase the pressure.
 - Turn counterclockwise to decrease the pressure.

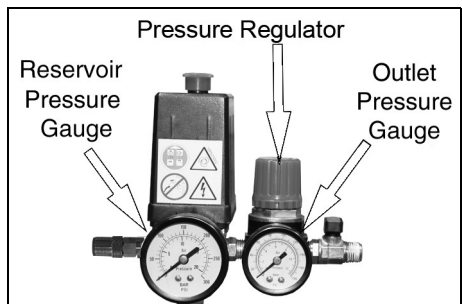

REMOVING TOOLS FROM THE AIR HOSE



WARNING: ALWAYS SET THE PRESSURE REGULATOR TO ZERO BEFORE YOU REMOVE OR REPLACE A TOOL.

1. Push down on the On/Off button to stop the compressor.

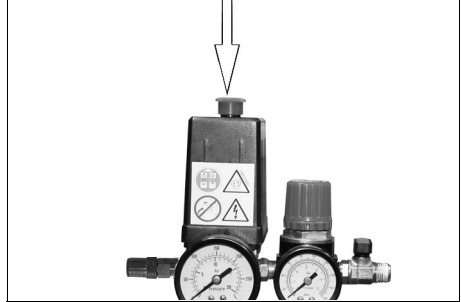

2. Turn the outlet valve handle to the off position.
3. Operate the tool to depressurize the air hose.
4. Disconnect the tool from the hose.

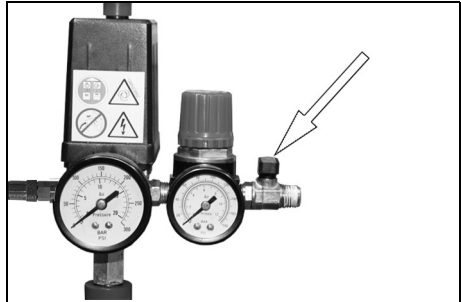

TURNING THE COMPRESSOR OFF

1. Follow steps 1-3 in "Removing Tools from the Air Hose" above.
2. Disconnect the compressor from the power supply.
3. Slowly open the outlet valve to depressurize the reservoir.
 - You will hear a hissing sound as the reservoir depressurizes.
4. Do not leave the compressor unattended if the reservoir is pressurised.



DRAINING THE RESERVOIR



CAUTION: YOU MUST DRAIN THE RESERVOIR AFTER EACH DAYS USE AND BEFORE YOU PUT YOUR COMPRESSOR INTO STORAGE.

1. Turn the compressor off and disconnect from the power supply.
2. Put a container below the drain valve to collect the condensate.
3. Open the drain valve slowly.
 - Condensation will drain from the reservoir.
4. Close the drain valve when the reservoir has fully drained.



USING THE RESET BUTTON

This compressor has a thermal overload device.

If the motor gets too hot, the thermal overload device cuts the power which prevents damage to the motor.

If the thermal overload device operates, let the motor cool down for 5 minutes and push the reset button.

If you start the compressor and the overload cutout operates again, stop the compressor and disconnect from the power supply and have your compressor examined by a qualified service agent

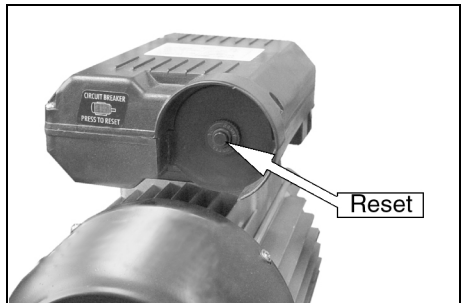

MAINTENANCE



WARNING: MAKE SURE THAT THE COMPRESSOR IS DISCONNECTED FROM THE ELECTRICAL SUPPLY BEFORE CARRYING OUT ANY MAINTENANCE

DRAIN THE RESERVOIR

After use, always open the drain valve to make sure that any condensate is drained off.

CHECK THE OIL

Ensure the oil level is between the min and max marks on the dipstick. See "Check the Oil level" on page 7 and top-up if necessary - (use SAE30 compressor oil available from your CLARKE dealer).

CLEAN THE AIR FILTER

The air filter must be examined monthly or more often in dusty conditions.

1. Remove the securing bolt and pull the filter from the compressor.

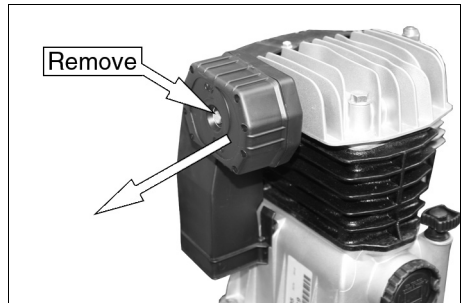

2. Unclip the front and rear of the filter and pull out the filter element.
3. Clean the filter using a soft brush.
 - If necessary, the filter can be carefully cleaned in warm soapy water.
 - Rinse and let the filter dry completely before refitting.

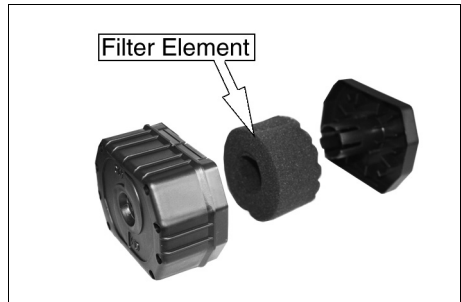

- If the filter or filter element is damaged, you must replace it.
4. Reassemble the filter and refit it to the compressor using the securing bolt.

REPLACING THE OIL

After the first 100 hours use, replace the oil using CLARKE ISO100 (SAE30) compressor oil. Then replace the oil after every 500 hours of operation or every 6 months.

To empty the oil from the engine, remove the oil drain plug from the crankcase.

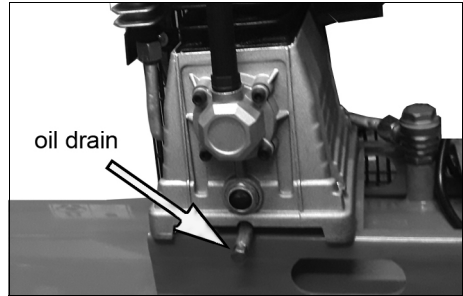

CHECKING THE NON-RETURN VALVE

If the reservoir pressure decreases for no apparent reason, it is possible that the non-return valve is leaking. To check this:

1. Make sure that the reservoir is not under pressure and the compressor is switched OFF.
2. Examine the non-return valve, and replace the gasket and valve if necessary.

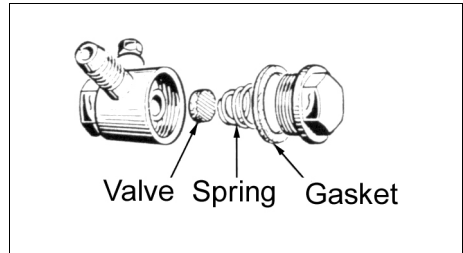
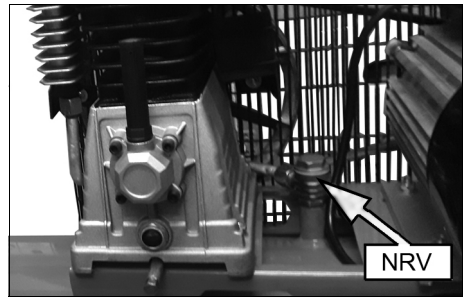

REPLACING THE DRIVE BELT



WARNING: MAKE SURE THAT THE COMPRESSOR IS DISCONNECTED FROM THE ELECTRICAL SUPPLY BEFORE REPLACING THE DRIVE BELT.

1. Rotate the clips on the front of the safety cage.
2. Remove the front of the cage and remove the damaged drive belt.
3. Pass the new drive belt over the small pulley first.
4. Pass the belt over the large pulley.
5. Rotate the large pulley by hand in a clockwise direction whilst guiding the belt on to it.
 - Take care to avoid trapping your fingers between the pulley and belt.
6. Replace the cage and secure before use.

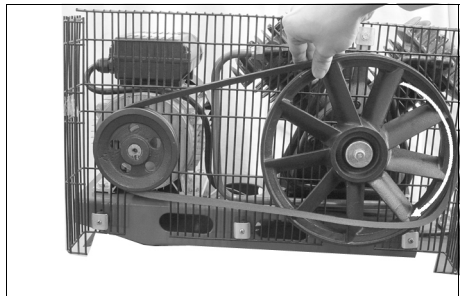
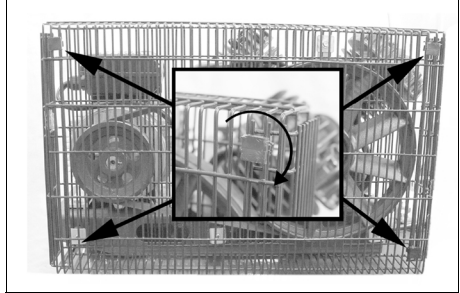

WARNING: NEVER USE THE COMPRESSOR WITH THE GUARD REMOVED.

TROUBLESHOOTING



CAUTION: DO NOT TRY TO REPAIR OR ADJUST IF YOU ARE UNCERTAIN. IF YOU HAVE ANY QUERIES, CONTACT YOUR CLARKE DEALER.

PROBLEM	PROBABLE CAUSE	REMEDY
The compressor has stopped and does not start.	Bad electrical connections.	<ol style="list-style-type: none"> 1. Check electrical connections. 2. Clean and tighten if necessary.
	Overload cutout switch has tripped.	<ol style="list-style-type: none"> 1. Switch off and wait approx 5 minutes. 2. Press the reset button and switch on again.
	Motor windings burnt out.	<ol style="list-style-type: none"> 1. Contact your CLARKE dealer for a replacement motor.
The compressor does not reach set pressure & overheats easily	Compressor head gasket blown or valve broken.	<ol style="list-style-type: none"> 1. Return the machine to your nearest service agent.
Compressor does not start.	The reservoir has already fully pressurised.	<ol style="list-style-type: none"> 1. Open drain valve to expel air. Compressor should start again when pressure reduces.
Air leaking from the non-return valve when the compressor is not running.	Faulty non-return valve.	<ol style="list-style-type: none"> 1. Fully drain receiver of air. 2. Remove valve end plug. 3. Carefully clean the valve seat and the gasket. 4. Reassemble.
Air pressure from the regulator will not adjust.	The diaphragm within the regulator body is broken.	<ol style="list-style-type: none"> 1. Replace regulator
The compressor is very noisy and makes metallic knocking sound.	Compressor damaged and needs overhaul.	<ol style="list-style-type: none"> 1. Return the machine to your nearest CLARKE dealer.

COMPONENT PARTS

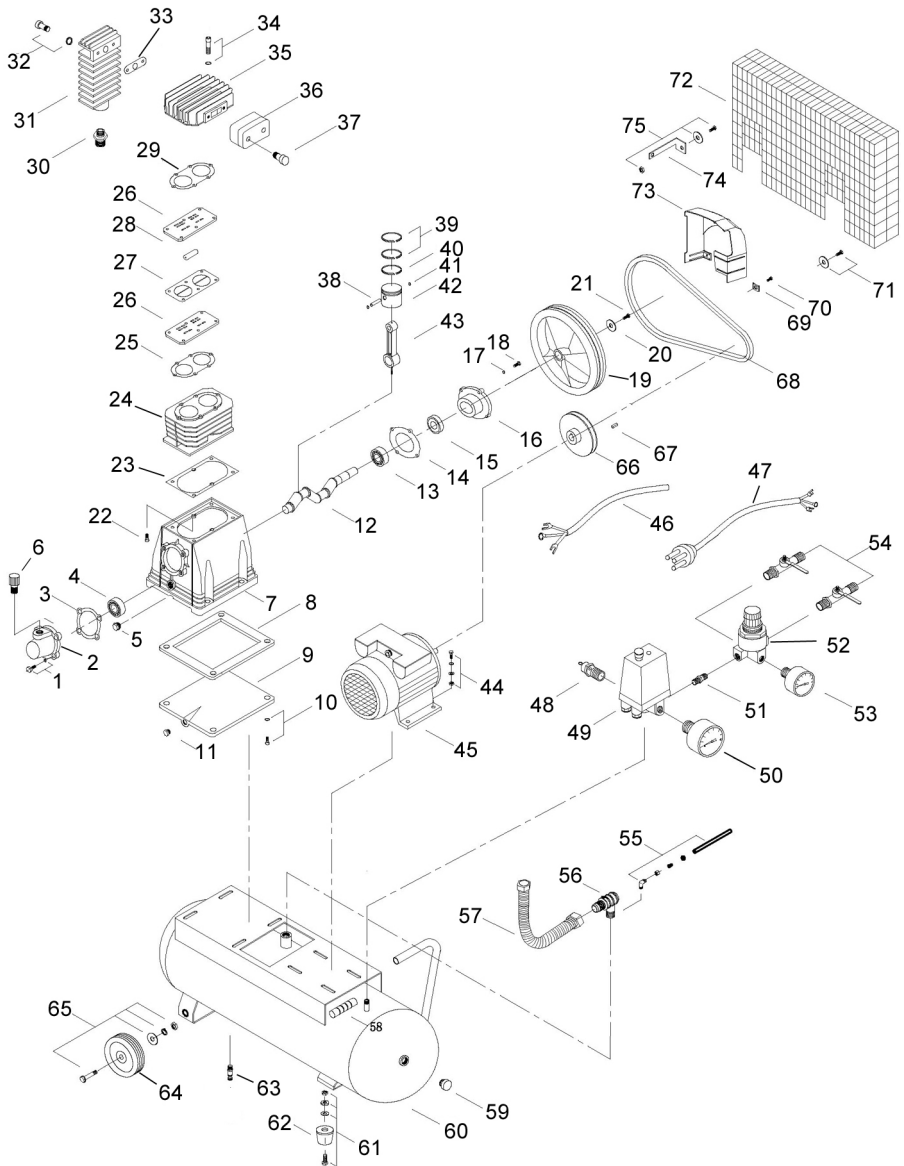

PARTS LIST

NO	DESCRIPTION
1	Screw & Spring Washer
2	Front Cover
3	Front Cover Gasket
4	Ball Bearing
5	Oil Sightglass Set
6	Breather (M16 x 1.5)
8	Crank Case
7	Baseplate Seal
9	Baseplate
10	Screw & Spring Washer
11	Oil Plug (G1/8")
12	Crankshaft
13	Ball Bearing
14	Bearing Seat Gasket
15	Oil Seal
16	Bearing Seat
17	Spring Washer
18	Hex Screw
19	Flywheel
20	Flywheel Flat Washer
21	Flywheel Screw
22	Hex Screw
23	Cylinder Gasket
24	Cylinder
25	Valve Plate Gasket
26	Valve Plate
27	Copper Gasket
28	Valve Reed
29	Head Cover Gasket
30	Connector Nut

NO	DESCRIPTION
31	Aftercooler
32	Screw & Spring Washer
33	Aftercooler Gasket
34	Screw & Spring Washer
35	Head Cover
36	Air Filter
37	Hex Screw
38	Gudgeon Pin
39	Compression Ring
40	Oil Ring
41	Circlip
42	Piston
43	Connecting Rod
44	Motor Fixing Parts
45	Motor
46	Motor Cable
47	Power Cable
48	Safety Valve
49	Pressure Switch
50	Pressure Gauge
51	Connector
52	Regulator
53	Pressure Gauge
54	Ball Valve
55	Discharge Pipe
56	Check Valve
57	Exhaust Pipe
58	Handle Cap
59	Hole Plug
60	Air Reservoir

NO	DESCRIPTION
61	Foot Fixing Parts
62	Foot
63	Drain Valve
64	Wheel
65	Wheel Fixing Parts
66	Motor Pulley
67	Key
68	V Belt

NO	DESCRIPTION
69	Flat Washer
70	Screw
71	Screw & Spring Washer
72	Safety Guard
73	Plastic Cowling
74	Bracket
75	Bracket Fixing Parts

SPECIFICATIONS

MODEL	AIRMASTER14/100P
Part Number	2245307
Motor Size	3 HP
Voltage	230 VAC (50Hz)
Air Displacement	394 L/min (14 cfm)
Max Pressure	10 Bar (145 psi)
Receiver Capacity	100 L
Ingress Protection	IP20
Fuse Rating	13 A
Duty cycle	S3/50%
Oil requirements	ISO100 (SAE30) compressor oil
Oil capacity	0.4L
Dimensions (L x W x H)	1040 x 370 x 760 mm
Guaranteed Sound Power Level	97 dB(A)
Weight	71 kg

DECLARATION OF CONFORMITY



Product Description: 100L Air compressor
Model number(s): Airmaster 14/100P
Serial / batch Number: 2245307
Date of Issue: 13/07/2021
(Noise Conformity)
Notified Body: TÜV SÜD Certification & Testing China Co, Ltd
Shanghai ranch 3-13F
No 151 Heng Tong Road
Shanghai 200070
China

Technical Documentation Holder:
A. R. Pond
Clarke International
2a Shrubland Road
London, E10 7RB
UK

Conformity Assessment Procedure: to 2000/14/EC Annex VI
Manufacturer: Clarke International
Noise Related Value: 2.2 kW
Measured Sound Power Level: 94 dB
Guaranteed Sound Power Level: 97 dB

Airmaster 14/100P CE Clarke-DOC 071321

Page 1 of 2



We hereby declare that this product(s) complies with the following directive(s):
2014/30/EU *Electromagnetic Compatibility Directive.*
2006/42/EC *Machinery Directive.*
2011/65/EU *Restriction of Hazardous Substances (amended by EU 2015/863).*
2014/29/EU *Simple Pressure Vessel Directive.*
2000/14/EC *Noise Emissions Directive, (amended by 2005/68/EC).*

The following standards have been applied to the product(s):

EN 61000-6-3:2007+A1:2011, EN 61000-6-11:2007, EN 60204-1:2006+A1:2009, EN 1012-1:2010,
EN 62321:2013, EN 62321-2:2014, EN 62321-3-1:2014, EN 62321-3-1:2014, EN 62321-4:2014+A1:2017, EN 286-1,
EN ISO 3744:1995.

The technical documentation required to demonstrate that the product(s) meet(s) the requirement(s) of the aforementioned directive(s) has been compiled and is available for inspection by the relevant enforcement authorities.

The CE mark was first applied in: 2021

Signed: 
J.A. Clarke
Director

Airmaster 14/100P CE Clarke-DOC 071321

Page 2 of 2

Machine Mart

A SELECTION OF OTHER QUALITY PRODUCTS



AIR COMPRESSORS
From DIY to industrial. Plus air tools,
spray guns and accessories.

GENERATORS
Prime duty or emergency standby
for business, home and leisure.

POWER WASHERS
Hot and cold, electric and engine
driven - we have what you need.

WELDERS
Mig, Arc, Tig and Spot. From DIY to
auto/industrial.

METALWORKING
Drills, grinders and saws for DIY and
professional use.

WOODWORKING
Saws, sanders, lathes, mortisers
and dust extraction.

HYDRAULICS
Cranes, body repair kits,
transmission jacks for all types of
workshop use.

WATER PUMPS
Submersible, electric and engine
driven for DIY, agriculture and
industry.

POWER TOOLS
Angle grinders, cordless drill sets,
saws and sanders.

STARTER/CHARGERS
All sizes for car & commercial use.

For Servicing and Spare Parts, please contact Machine Mart on one of the following numbers

PARTS: 0871 410 1270 SERVICE: 0871 410 1290